

Please check the examination details below before entering your candidate information

Candidate surname

Other names

**Pearson Edexcel  
International GCSE**

Centre Number

--	--	--	--	--

Candidate Number

--	--	--	--	--

**Wednesday 15 January 2020**

Morning (Time: 2 hours)

Paper Reference **4MA1/2H**

**Mathematics A**  
**Paper 2H**  
**Higher Tier**



**You must have:**

Ruler graduated in centimetres and millimetres, protractor, compasses, pen, HB pencil, eraser, calculator. Tracing paper may be used.

Total Marks

### Instructions

- Use **black** ink or ball-point pen.
- **Fill in the boxes** at the top of this page with your name, centre number and candidate number.
- Answer **all** questions.
- Without sufficient working, correct answers may be awarded no marks.
- Answer the questions in the spaces provided  
– *there may be more space than you need.*
- **Calculators may be used.**
- You must **NOT** write anything on the formulae page.  
Anything you write on the formulae page will gain **NO** credit.

### Information

- The total mark for this paper is 100.
- The marks for **each** question are shown in brackets  
– *use this as a guide as to how much time to spend on each question.*

### Advice

- Read each question carefully before you start to answer it.
- Check your answers if you have time at the end.

Turn over ►

P59762A

©2020 Pearson Education Ltd.

1/1/



  
Pearson

International GCSE Mathematics

Formulae sheet – Higher Tier

**Arithmetic series**

Sum to  $n$  terms,  $S_n = \frac{n}{2} [2a + (n - 1)d]$

**Area of trapezium** =  $\frac{1}{2}(a + b)h$

**The quadratic equation**

The solutions of  $ax^2 + bx + c = 0$  where  $a \neq 0$  are given by:

$$x = \frac{-b \pm \sqrt{b^2 - 4ac}}{2a}$$

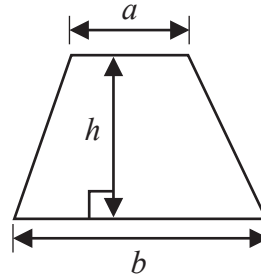

**Trigonometry**

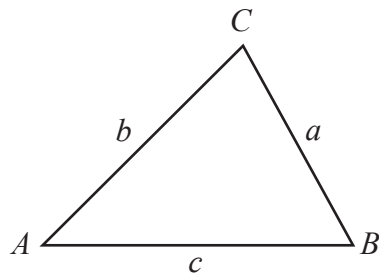

**In any triangle ABC**

**Sine Rule**  $\frac{a}{\sin A} = \frac{b}{\sin B} = \frac{c}{\sin C}$

**Cosine Rule**  $a^2 = b^2 + c^2 - 2bc \cos A$

**Area of triangle** =  $\frac{1}{2}ab \sin C$

**Volume of cone** =  $\frac{1}{3}\pi r^2 h$

**Curved surface area of cone** =  $\pi r l$

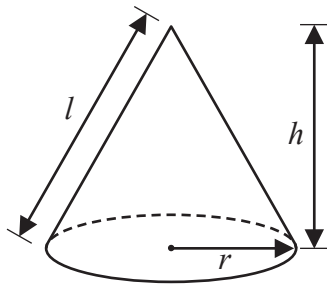

**Volume of prism**

= area of cross section  $\times$  length

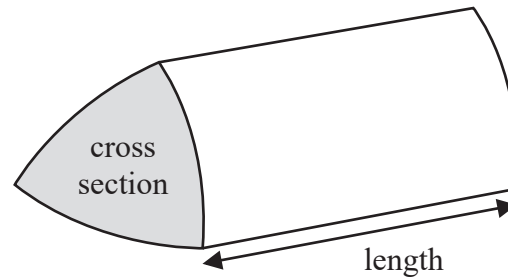

**Volume of cylinder** =  $\pi r^2 h$

**Curved surface area of cylinder** =  $2\pi r h$

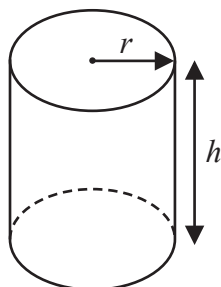

**Volume of sphere** =  $\frac{4}{3}\pi r^3$

**Surface area of sphere** =  $4\pi r^2$

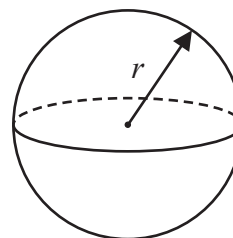

DO NOT WRITE IN THIS AREA

DO NOT WRITE IN THIS AREA

DO NOT WRITE IN THIS AREA



Answer ALL TWENTY SIX questions.

Write your answers in the spaces provided.

You must write down all the stages in your working.

1 (a) Simplify  $\frac{x^9}{x^2}$

.....  
(1)

(b) Write  $\frac{7^8 \times 7^4}{7^3}$  as a single power of 7

.....  
(2)

(Total for Question 1 is 3 marks)

2 Change 32.4 m<sup>3</sup> into cm<sup>3</sup>

..... cm<sup>3</sup>

(Total for Question 2 is 2 marks)



3 Show that  $4\frac{2}{3} + 3\frac{4}{5} = 8\frac{7}{15}$

DO NOT WRITE IN THIS AREA

DO NOT WRITE IN THIS AREA

(Total for Question 3 is 3 marks)

DO NOT WRITE IN THIS AREA



4 The diagram shows a triangle.

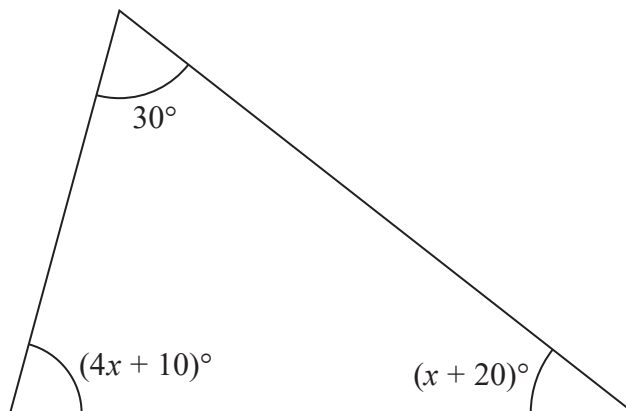

Diagram **NOT**  
accurately drawn

Work out the value of  $x$ .

$x = \dots\dots\dots$

**(Total for Question 4 is 4 marks)**



- 5 Use ruler and compasses to construct the bisector of angle  $BAC$ .  
You must show all your construction lines.

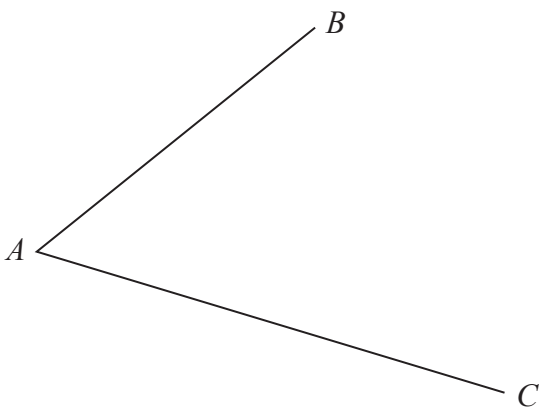

(Total for Question 5 is 2 marks)

DO NOT WRITE IN THIS AREA

DO NOT WRITE IN THIS AREA

DO NOT WRITE IN THIS AREA



- 6 A bag contains only red beads, blue beads, green beads and yellow beads.

The table gives the probabilities that, when a bead is taken at random from the bag, the bead will be blue or the bead will be yellow.

<b>Colour</b>	<b>red</b>	<b>blue</b>	<b>green</b>	<b>yellow</b>
<b>Probability</b>		0.24		0.31

The probability that the bead will be green is twice the probability that the bead will be red.

Sofia takes at random a bead from the bag.

She writes down the colour of the bead and puts the bead back into the bag.

She does this 180 times.

Work out an estimate for the number of times she takes a red bead from the bag.

.....  
(Total for Question 6 is 4 marks)



7 (a) Solve the inequality  $2x + 7 > 4$

.....  
(2)

(b) Solve  $x^2 - 3x - 40 = 0$   
Show clear algebraic working.

.....  
(3)

**(Total for Question 7 is 5 marks)**

---

DO NOT WRITE IN THIS AREA

DO NOT WRITE IN THIS AREA

DO NOT WRITE IN THIS AREA





- 8 The table shows the cost, in euros, of Brigitte's car insurance in each of the years 2016, 2017 and 2018

Year	2016	2017	2018
Cost of insurance (euros)	500	545	592

Brigitte says,

“The percentage increase in the cost of my car insurance from 2017 to 2018 is more than the percentage increase in the cost of my car insurance from 2016 to 2017”

- (a) Is Brigitte correct?  
You must show how you get your answer.

(4)

Henri wants to insure his car.

He gets a discount of 15% off the normal price.

Henri pays 952 euros for his car insurance after the discount.

- (b) Work out the discount that Henri gets.

..... euros

(3)

(Total for Question 8 is 7 marks)



- 9 The density of gold is  $19.3 \text{ g/cm}^3$   
A gold bar has volume  $150 \text{ cm}^3$

Work out the mass of the gold bar.

..... 20

**(Total for Question 9 is 2 marks)**

- 10 Change a speed of 50 metres per second to a speed in kilometres per hour.

..... kilometres per hour

**(Total for Question 10 is 3 marks)**



DO NOT WRITE IN THIS AREA

DO NOT WRITE IN THIS AREA

DO NOT WRITE IN THIS AREA

11 The diagram shows a shaded shape  $ABCD$  made from a semicircle  $ABC$  and a right-angled triangle  $ACD$ .

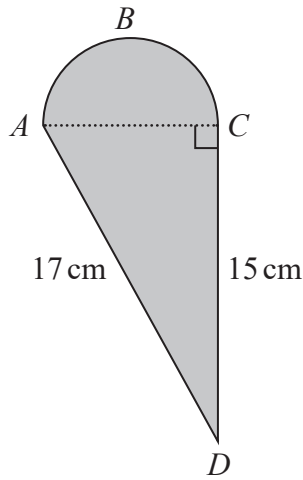

Diagram NOT accurately drawn

$AC$  is the diameter of the semicircle  $ABC$ .

Work out the perimeter of the shaded shape.  
Give your answer correct to 3 significant figures.

..... cm

(Total for Question 11 is 5 marks)



- 12 Astrid wants to buy some oil.  
She can buy the oil from either Dane Oil or Arctic Oil.

Here is information about the price that each company will charge Astrid.

Dane Oil	Arctic Oil
$(4.2 \times 10^5)$ litres for 2 500 000 Krone	$(8.6 \times 10^5)$ litres for 770 000 Dollars

Astrid wants to get the better value for money for the oil.

$$1 \text{ Dollar} = 6.57 \text{ Krone}$$

From which company should she buy her oil, Dane Oil or Arctic Oil?  
You must show your working.

(Total for Question 12 is 4 marks)

DO NOT WRITE IN THIS AREA

DO NOT WRITE IN THIS AREA

DO NOT WRITE IN THIS AREA



13

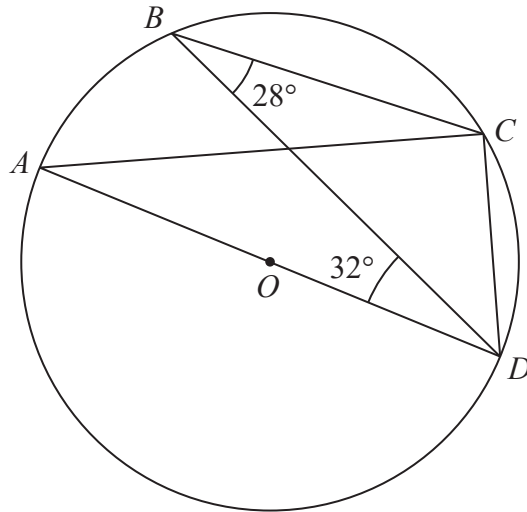

Diagram NOT accurately drawn

$A$ ,  $B$ ,  $C$  and  $D$  are points on a circle, centre  $O$ .  
 $AOD$  is a diameter of the circle.

Angle  $CBD = 28^\circ$   
Angle  $BDA = 32^\circ$

Find the size of angle  $BDC$ .  
Give a reason for each stage of your working.

.....  
(Total for Question 13 is 4 marks)



14 There are 20 glasses in a cupboard.

13 of the glasses are large  
7 of the glasses are small

Roberto takes at random two glasses from the cupboard.

(a) Complete the probability tree diagram.

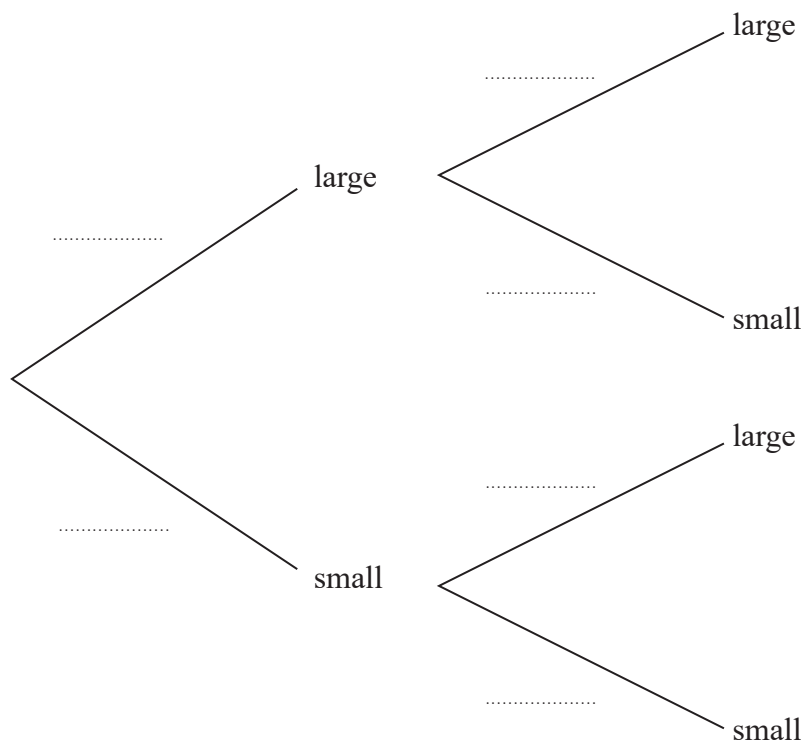

(2)

(b) Work out the probability that Roberto takes two small glasses.

(2)

(Total for Question 14 is 4 marks)



15 Here are six graphs.

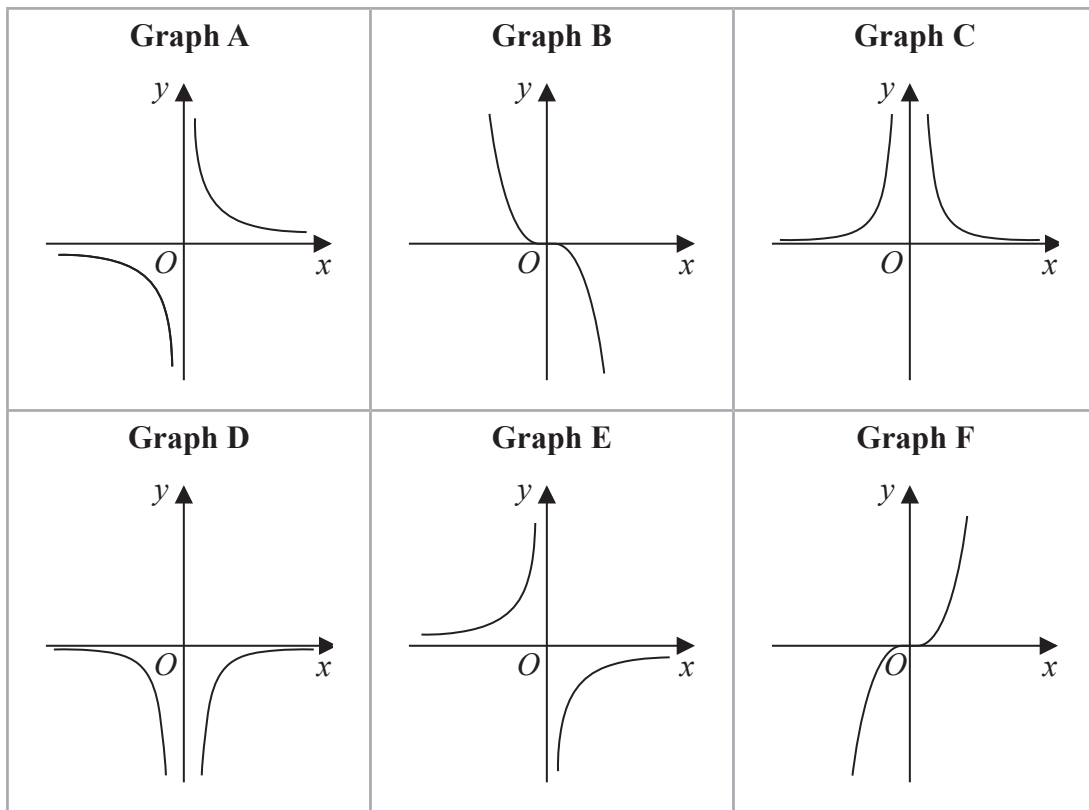

Complete the table below with the letter of the graph that could represent each given equation.

Write your answers on the dotted lines.

Equation	Graph
$y = \frac{2}{x^2}$	.....
$y = -\frac{1}{2}x^3$	.....
$y = -\frac{5}{x}$	.....

(Total for Question 15 is 3 marks)



16 Make  $x$  the subject of  $y = \sqrt{\frac{x+1}{x-4}}$

DO NOT WRITE IN THIS AREA

DO NOT WRITE IN THIS AREA

DO NOT WRITE IN THIS AREA

.....  
(Total for Question 16 is 4 marks)





DO NOT WRITE IN THIS AREA

DO NOT WRITE IN THIS AREA

DO NOT WRITE IN THIS AREA

17 Prove that the difference between two consecutive square numbers is always an odd number.  
Show clear algebraic working.

(Total for Question 17 is 3 marks)



18 The histogram gives information about the times, in minutes, that some customers spent in a supermarket.

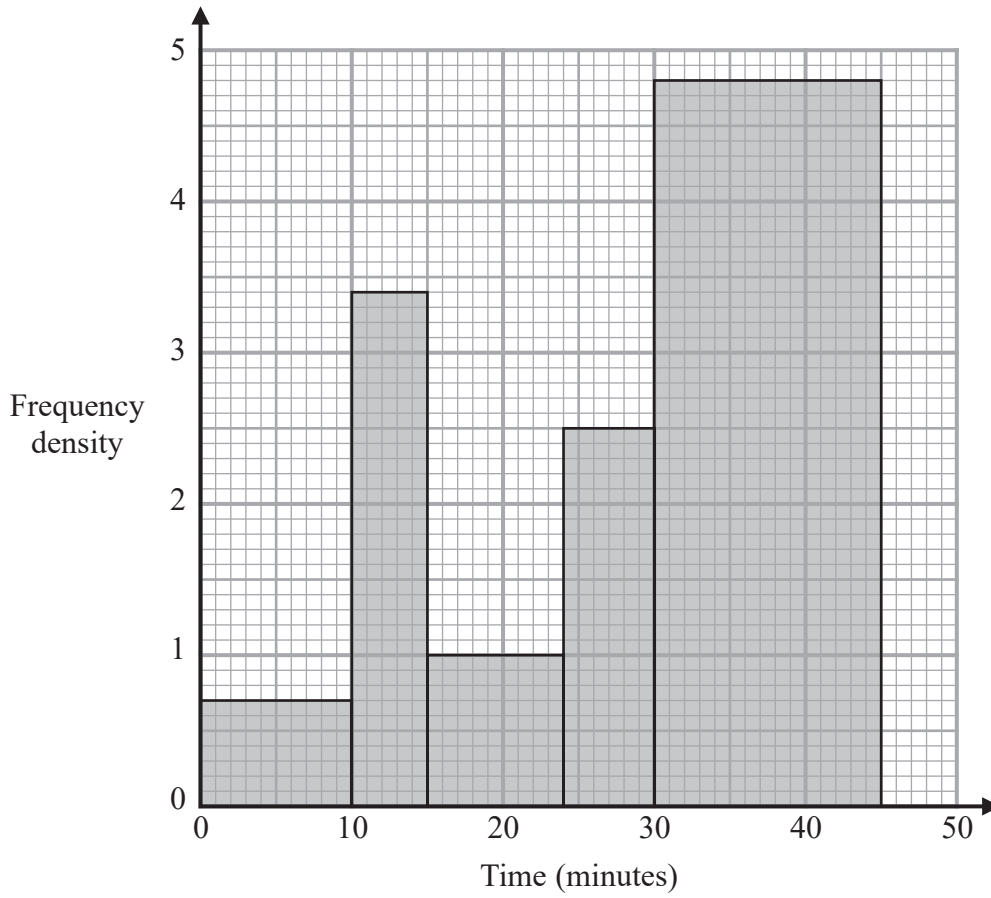

(a) Work out an estimate for the proportion of these customers who spent between 17 minutes and 35 minutes in the supermarket.

(3)

DO NOT WRITE IN THIS AREA

DO NOT WRITE IN THIS AREA

DO NOT WRITE IN THIS AREA



One of the customers is selected at random.

Given that this customer had spent more than 30 minutes in the supermarket,

(b) find the probability that this customer spent more than 36 minutes in the supermarket.

.....  
(2)

(Total for Question 18 is 5 marks)

19 (a) Write down an equation of a line that is parallel to the line with equation  $y = 7 - 4x$

.....  
(1)

The line L passes through the points with coordinates  $(-3, 1)$  and  $(2, -2)$

(b) Find an equation of the line that is perpendicular to L and passes through the point with coordinates  $(-6, 4)$

Give your answer in the form  $ax + by + c = 0$  where  $a$ ,  $b$  and  $c$  are integers.

.....  
(4)

(Total for Question 19 is 5 marks)



20 The area of a rectangle is  $18 \text{ cm}^2$

The length of the rectangle is  $(\sqrt{7} + 1) \text{ cm}$ .

Without using a calculator and showing each stage of your working,

find the width of the rectangle.

Give your answer in the form  $a\sqrt{b} + c$  where  $a$ ,  $b$  and  $c$  are integers.

..... cm

**(Total for Question 20 is 3 marks)**



21 The diagram shows a sketch of part of the curve with equation  $y = f(x)$

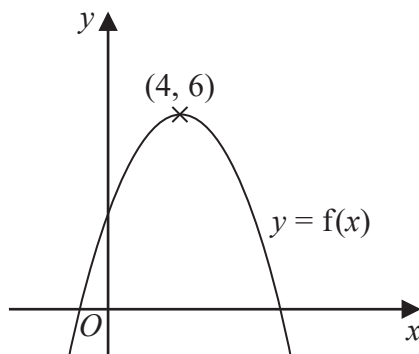

There is one maximum point on this curve.  
The coordinates of this maximum point are  $(4, 6)$

(a) Write down the coordinates of the maximum point on the curve with equation

(i)  $y = f(x + 4)$

(....., .....) (1)

(ii)  $y = f(2x)$

(....., .....)  
(2)

The equation of a curve **C** is  $y = x^2 + 3x + 4$

The curve **C** is transformed to curve **S** under the translation  $\begin{pmatrix} 4 \\ 6 \end{pmatrix}$

(b) Find an equation of curve **S**.

*You do not need to simplify the equation.*

.....  
(2)

(Total for Question 21 is 4 marks)



22 The line with equation  $y = x + 2$  intersects the curve with equation  $x^2 + y^2 - 2y = 24$  at the points  $A$  and  $B$ .

Find the coordinates of  $A$  and  $B$ .

Show clear algebraic working.

(....., .....)

(....., .....)

(Total for Question 22 is 5 marks)

DO NOT WRITE IN THIS AREA

DO NOT WRITE IN THIS AREA

DO NOT WRITE IN THIS AREA



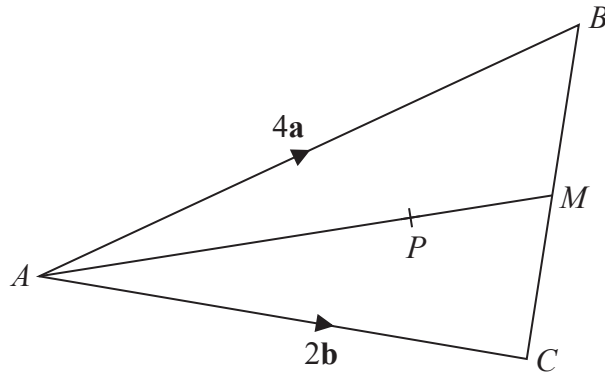

Diagram **NOT**  
accurately drawn

$ABC$  is a triangle.  
The midpoint of  $BC$  is  $M$ .  
 $P$  is a point on  $AM$ .

$$\vec{AB} = 4\mathbf{a}$$

$$\vec{AC} = 2\mathbf{b}$$

$$\vec{AP} = \frac{3}{2}\mathbf{a} + \frac{3}{4}\mathbf{b}$$

Find the ratio  $AP:PM$

(Total for Question 23 is 3 marks)



24 Express

$$\left( \frac{4}{2x-5} - \frac{3}{2x-3} \right) \div \frac{9x-4x^3}{6x^2-17x+5}$$

as a single fraction in its simplest form.

DO NOT WRITE IN THIS AREA

DO NOT WRITE IN THIS AREA

DO NOT WRITE IN THIS AREA

(Total for Question 24 is 4 marks)





DO NOT WRITE IN THIS AREA

25 Mario is going to save \$50 in the year 2021

He is going to continue to save, up to and including the year 2070, by increasing the amount he saves each year by \$ $k$

Mario will save a total of \$33 125 from 2021 to 2070

Work out the value of  $k$ .

$k = \dots\dots\dots$

(Total for Question 25 is 3 marks)



26 Here is a sector,  $AOB$ , of a circle with centre  $O$  and angle  $AOB = x^\circ$

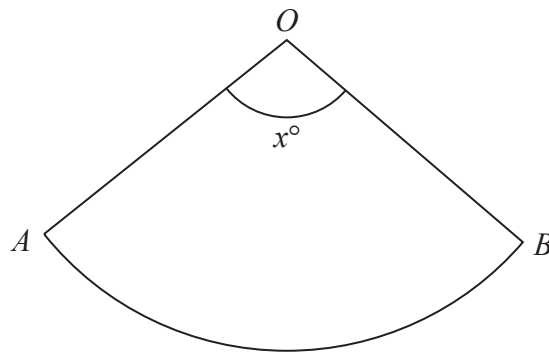

Diagram **NOT** accurately drawn

The sector can form the curved surface of a cone by joining  $OA$  to  $OB$ .

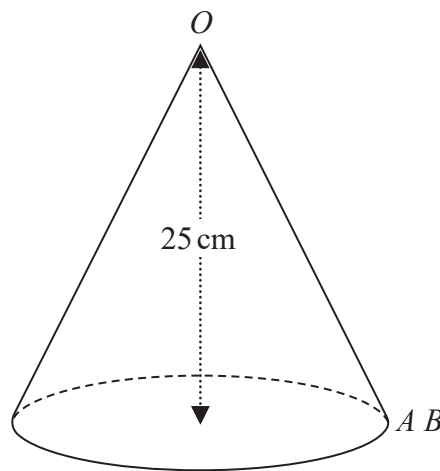

Diagram **NOT** accurately drawn

The height of the cone is  $25\text{ cm}$ .  
The volume of the cone is  $1600\text{ cm}^3$

Work out the value of  $x$ .  
Give your answer correct to the nearest whole number.

DO NOT WRITE IN THIS AREA

DO NOT WRITE IN THIS AREA

DO NOT WRITE IN THIS AREA



DO NOT WRITE IN THIS AREA

DO NOT WRITE IN THIS AREA

DO NOT WRITE IN THIS AREA

$x =$  .....

**(Total for Question 26 is 6 marks)**

**TOTAL FOR PAPER IS 100 MARKS**



P 5 9 7 6 2 A 0 2 7 2 8

DO NOT WRITE IN THIS AREA

DO NOT WRITE IN THIS AREA

DO NOT WRITE IN THIS AREA

**BLANK PAGE**

